



TA2 New Zealand

PBR SPECIFICATION-
POWERED BY MCLAREN



2023 - 2024

TA2 MUSCLE CAR SERIES NZ TECHNICAL REGULATIONS



SCHEDULE 1 | 2023-2024 TECHNICAL REGULATIONS

Table of Contents

Page Number

1.0	Overview	3
2.0	General Specifications:	3,4,5
3.0	Chassis – Howe TA2 NZ/PBR Spec only	5
4.0	Body.....	5,6,7
5.0	Engine	7,8,9
6.0	Driveline.....	9,10
7.0	Brakes	10,11
8.0	Suspension and Steering.....	11,12,13
9.0	Electrical and Data	13,14
10.0	Wheels and Tyres.....	14
11.0	Safety.....	14,15
12.0	Bolts and Fasteners	15,16
13.0	Identification and Markings	16
14.0	Performance Upgrades or Rule Updates	16,17

2023-2024 TECHNICAL REGULATIONS

1.0 Overview

“TA2 Racing New Zealand” referred to as “TA2 Racing”, “TA2 Muscle Car Series” ,“TA2” OR “TA2 NZ” for the duration of these Articles.

TA2 Muscle Car Series will be run BY NZ TOURING CARS and TA2 NEW ZEALAND under agreement with PBR Distributions and TA2 Racing Australia. To be eligible to race in the TA2 Muscle Car Series in New Zealand , each competitor must purchase a New TA2 car through TA2 New Zealand. Additionally respecting all Technical Regulations and Vehicle eligibility as stated in these Articles.

The spirit and intent of these Articles is to give a consistent and clear understanding of the Technical Regulations for the TA2 Muscle Car Series in New Zealand.

If you are unsure if a modification or repair you are about to perform is acceptable within the Technical Regulations, then contact MUST be made with TA2 NZ Technical Manager (TM) **PRIOR** to commencing any work.

All Technical Regulation clarifications, questions and enquiries must be made via email to the NZ Technical Manager (Contact list on page 16) by a person with an interest in a **recognized TA2 Racing Car**. No enquiries will be considered from a person without direct connection to a TA2 Racing Car or anyone who DOES NOT hold an official position in a TA2 Race Team.

These Technical Regulations and Articles are to benefit the class of **TA2 Muscle Car Series NZ** as a whole.

Consideration will be given to individual circumstances, but the design is to keep the cars at an even mechanical level with no advantage to any one competitor, while keeping cost to a minimum for this level of Motorsport.

These regulations shall be read in conjunction with the MotorSport New Zealand National Sporting Code, the Standing Regulations as detailed in the current edition of the MotorSport New Zealand Manual, and the Supplementary Regulations issued by the Organiser for each Round of the Series. Additionally, any subsequent amendments / bulletins as issued by MotorSport New Zealand from time to time shall be respected.

DEFINITION: “As standard” “Controlled Parts”- as supplied by the original manufacturer and distributed through TA2 NZ and or TA2 NZ Pty Ltd.

The over-riding philosophy in respect to the eligibility of any area of the TA2 race vehicle will always defer to the “as standard” “Controlled Parts” specification of the vehicle, and/or “as the vehicle was manufactured by Howe Racing, supplied and delivered by TA2 NZ”.

2.0 General Specifications:

2.1 TA2 NZ Race Vehicle Specifications

Minimum Ride Height	65mm
Wheelbase	2640 mm plus or minus 25.4 mm
Wheel Track Front	2000 mm plus or minus 25.4 mm (outside of tyre to outside of tyre)
Wheel Track Rear	2000 mm plus or minus 25.4 mm (outside of tyre to outside of tyre)
Minimum Weight	1250 kg (including driver)

2.2 Engine and Transmission Location

Engine and transmission location must remain un-modified. All engines must remain mounted to original mounting points in the chassis.

2.3 Driver Position

The driver must sit to the left of the center line. No portion of the driver's seat or restraint system can cross the center line of the car. The driver's position is set by the manufacturer and only front and back adjustment is allowed.

2.4 Fuel Cell Size: 22Gal/ 84ltr

Fuel: Commercially available 98 Octane BP Ultimate/Gull/Mobil ONLY. No blending or mixing of additives with the standard pump fuel. The Category Manager/TA2 NZ may nominate a control fuel supplier for some or all rounds of the series and teams will be advised prior to the round. Fuel may be checked by the Series scrutineer via the fuel check valve or by direct drainage from the tank at any time during a sanctioned TA2 Race event.

2.5 TA2 NZ Controlled Parts.

- (a) All suspension and controlled parts fitted **MUST BE PURCHASED** through TA2 NZ, even if these parts are available from a normal or specialized retail outlet.
- (b) These parts are vital to keeping the class of TA2 Racing equal and the mechanical specifications of the cars as equal as possible. The parts listed below are vital and could be easily modified to give an individual car an un-fair advantage. The following parts must be purchased through TA2 NZ.

Upper Control arm (front)	2213407
Lower Control arm (RH front)	229926R
Lower Control arm (LH front)	229926L
Lower Ball Joints	22410
Upper Ball joints	22320
Front Sway Bar 170	2373134
Front Sway Bar 250	23732
Front Up-right R/H (stub) Zero offset spindle slug	34611W
Front Up-right L/H (stub) Zero offset spindle slug	34611LW
Electronic Control Module	PF062
Axle L/H	TG3001-34
Axle R/H	TG3001-34
Caster strut	30618
Brake Rotor Wilwood RHF	WW160-11839
Brake Rotor Wilwood LHF	WW160-11840
Brake Rotor Wilwood RHR	WW160-13499
Brake Rotor Wilwood LHR	WW160-13500
Front Hub	205800
Rear Hub	205300
Bassett Rim	B50L55
Hyper coil springs F&R	Linear rate only part # HY10B0###
Penske Shocks	PK7500COSA
All Body Panels	5 Star/Howe Racing/TA2 NZ/PBR approved
Tiger Quick Change Rear End	TG20103
Brake Pads Circo HD Front TA2 Competition Spec	MB1812-20-M207
Brake Pads Circo Rear TA2 Competition Spec	MB2690-20-S83

Windscreen Camaro	FS81131-63343
Windscreen Mustang	FS81321-63343
Windscreen Challenger	B8019D
Gearbox (Sealed)	G101A-TA2 NZ/PBR
Separate Clutch Reservoir	524358
LS Engine (Sealed)	LSCC-TA2 NZ/PBR
Hoosier Slick Tyres	HS3045
Hoosier Wet tyres	HSWET
Detroit Locker	TG2403

3.0 Chassis – Howe TA2 NZ/PBR Spec only

The Howe TA2 NZ/PBR approved chassis must be used.

- (a) Only cars purchased via TA2 NZ Pty Ltd will be eligible to compete in the NZ TA2 Muscle Car Series Events.
- (b) Strictly no modification to the chassis/frame under any circumstances.
- (c) Additional mounts may be fitted with prior written approval from TA2 Racing NZ.
- (d) Chassis must remain in good order and provide the driver with protection in the case of an accident. Damage to a major chassis member must be repaired or replaced to the highest standards and meet the satisfaction of the Series scrutineer. Cars involved in a major accident will have the damage noted in their Log Book.
- (e) Any modification to suspension pick-up points, engine mounting points or mounting plates or bolts is strictly forbidden.
- (f) Added weight must be in block form. No single block can weigh more than 15kg. Any weight used must be within the chassis rails side to side, within the center line of the front and rear wheels and be directly bolted to the chassis plates as provided in the manufacturing of the Car.
- (g) No movable weight.
- (h) No weight trays other than those provided on the chassis by Howe.
- (i) All added weight blocks must be a bright colour and have the car chassis and/or car race number clearly marked on each weight.
- (j) Weight must be attached via positive means to the satisfaction of the scrutineer (12mm 8.8 or better Bolts & Lock Nuts).
- (k) No added weight in the driver's compartment.
- (l) Any TA2 car that has added weight fall off during a TA2 Muscle Car Round will be subject to penalties.
- (m) Air Jacks are not permitted except for those cars factory fitted with air jacks that have been imported into New Zealand by TA2 NZ prior to 1/1/2022. Currently this covers Chassis Number H3907.

4.0 Body

- 4.1 All replacement body panels must be supplied by TA2 NZ and be of Five Star or TA2 NZ/PBR make.
- 4.2 Repairs to body panels is permitted however it must not change the shape of the panels to aid in aerodynamic performance.

- 4.3** Cowl panel (below windscreen) must remain unchanged – all engine intake air or cooling air must come through the front bumper grille sections and hood vents only.
- 4.4 Grille**
- (a) Grille inserts are permitted however, must be TA2 spec part no. TA2-0033. Only 2 grille inserts allowed and must be located within Grill airbox frontal area. Bumper sections may not be modified.
 - (b) Grilles must retain the original profile as viewed from the top, sides, and front.
 - (c) Please refer to Appendix 9, 10 and 11 for Grille openings on the upper nose section for all bodies.
 - (d) Grille mesh material is unregulated and can be changed, noting that small aperture mesh should not impede air flow to the radiator, nor large mesh allow debris to pass through causing radiator damage.
- 4.5** Quarter panels must remain unmodified other than repairs to damage.
- 4.6** Rear boot/trunk must remain unmodified other than repairs.
- 4.7** Rear wing mounts are to remain unmodified.
- 4.8 Hoods/Bonnet**
- (a) Hoods/Bonnet must remain unmodified.
 - (b) Additional fasteners are allowed on the hood/Bonnet section. Hood pins may be upgraded or changed. The hood must have a minimum of eight fastening points. Hood pins must not form any type of aerodynamic aid.
- 4.9** Internal tinwork should remain unchanged from original standard design, providing it affords the driver with safe insulation from the driveline and engine bay area. A positive fire wall is required on all four sides of the driver. The floor must remain minimum 1/8" magnetic steel plate. Tin work must be of neat appearance and have no sharp edges.
- 4.10** Windscreens must be fitted, and
- (a) The front windscreen must be TA2 spec/Five Star Clear sheet and have no holes other than the mounting holes. All replacement windscreens must be TA2 spec/Five Star screens only.
 - (b) The rear windscreens must be TA2 Spec/Five Star screen only.
 - (c) Windscreen protectors are allowed.
 - (d) TA2 NZ Specification passenger and driver side windows are permitted during wet track sessions ONLY.
- 4.11 Aerodynamics**
- (a) The Standard factory front splitter is permitted (Part No. FS81001-41851) or alternate material (paper rock) can be used only if approved by TA2 NZ. All splitter/undertrays are required to be no longer than 620mm deep with a 5mm tolerance and must follow without protruding past the profile and of the further most point of the front bumper and air dam.
 - (b) A distance from the center line of the front cross member to the back edge of the splitter/undertray is to be no less than:
355mm on the Dodge,
345mm on the Camaro and Mustang.

- (c) Splitter/Undertray thickness is to be no thicker than 9mm and no thinner than 6mm.
- (d) The allowance of a wear strip to the front underside edge of a fitted one-piece fibreglass nose cone is permitted but, must be no wider than 50mm and no thicker than 9mm and is not to protrude outside of the nose profile. Please refer to **Appendix 12**.
- (e) Additionally a controlled steel wear plate may be purchased via TA2 NZ.
- (f) The profile must remain as standard. No additional aerodynamic aids are to be attached to any section of the as standard supplied body. Please refer to the drawings in **Appendix 3 and 4**.
- (g) Taping or covering of any body panel gaps is not permitted.
- (h) Manipulation of body panels, beyond their relaxed state, is not permitted INCLUDING FRONT SPLITTER.

4.12 Rear Wing

- (a) TA2 AUSTRALIA/NZ Spec Rear Wing must be fitted and unmodified.
- (b) TA2 AUSTRALIA/NZ Spec Rear Wing hardware and mounts must not be modified.
- (c) No packers or shims can alter the standard TA2 AUSTRALIA/NZ spec wing.
- (d) No other aerodynamic aids are permitted on the wing.
- (e) Only Standard TA2 AUSTRALIA/NZ wing end plates are permitted.

4.13 NACA ducts or air inlet ducts may be fitted in the side window openings. These may provide air to the driver or as a means of windscreen demisting. This air MUST NOT be forced into the engine compartment. Ducts must in no way impede the driver's ability to remove themselves from the vehicle in the case of an emergency.

4.14 The TA2 NZ Controlled Part Side mirrors must not be modified and must always be fitted. (unless damaged in a current race).

4.15 The TA2 NZ Controlled Part internal rear-view mirror is required.

4.16 Aerials and antennas may be fitted to the roof or boot/trunk.

4.17 Internal and external cameras are permitted in accordance with Schedule A; these must be fastened securely and must be present and secure when the vehicle is produced for scrutineering.

4.18 TA2 AUSTRALIA/NZ spec front and rear tow straps must be fitted. Tow straps must be easily accessible and clearly marked.

5.0 Engine

TA2 Racing Australia LS3 supplied engines only. All engines must be purchased through TA2 NZ.

- (a) All engines come complete and are Category sealed for even performance, integrity, and identification.
- (b) No modifications to the components of the engine are permitted, other than ones mentioned in these Regulations.
- (c) Replacement components not identical in their supplier and part number are not to be used unless specific permission is granted, via writing from TA2 Racing New Zealand Management.

- (d) Throttle must have a minimum of two return springs that positively return throttle to its idle position.
- (e) Improved throttle pedal assembly is permissible however, must be TA2 spec part no.52350.
- (f) Fuel pump must remain the original type, mounting position and unmodified (255 LPM).
- (g) K&N Filter elements are permitted.
- (h) TA2 AUSTRALIA/NZ supplied airbox only, filter location must remain unchanged, all engine intake air must pass by the inlet air filter and throttle body. No other inlet air to the engine is permitted.
- (i) Exhaust manifold including the TA2 NZ Controlled Part muffler and their exit location must remain standard. Extractor header pipes are a TA2 NZ Controlled parts. No modification to these parts is permitted.
- (j) TA2 spec noise augers and turndowns are permitted when required to meet noise level regulations.
- (k) Rocker cover type and design is Unregulated.
- (l) The TA2 NZ Controlled Part Water pump must be crankshaft belt driven.
- (m) An engine crankshaft belt driven alternator must be fitted and the alternator must be operational.
- (n) The engine must be able to start under its own power at any time as requested by the TA2 NZ Series scrutineer.
- (o) Starter motor position is fixed.
- (p) Spark plugs are Unregulated.
- (q) The TA2 NZ Controlled Part Coolant pipes are to remain standard.
- (r) Radiator and oil cooler type and position are fixed. Only the Controlled TA2 NZ Part Spec Units purchased via TA2 NZ are permissible.
- (s) A fuel sample point must be installed in the same location as indicated in the pictures detailed on **Appendix 5**. Part no. XARO15631 is the mandated valve that must be used.
- (t) The TA2 NZ Controlled Part Thermo fans are to remain as supplied and retained in the 'as standard' location.
- (u) The TA2 NZ Controlled Part TA2 spec ECM units must be used. Strictly no tampering or modifications are to be made to this part. Penalties will apply to anyone competing in a TA2 NZ Series event with a modified ECM. The Series scrutineer can, at any time, check the operation of the rev limiter. All ECM Rev limiters are set to 6700 rpm with no tolerance. TA2 Racing NZ reserves the right to test all or any ECM at any race event. At the direction of the TA2 NZ Series Scrutineer, an ECM Unit owned by TA2 NZ may be supplied and the competitor directed to race or qualify using the TA2 NZ supplied unit. Refusal to replace the ECU at the direction of the Series Scrutineer will be treated as a material breach of the technical regulations and penalties will apply. Engine repairs/rebuilding will be completed by contractors to TA2 NZ Pty Ltd (TA2 NZ/PBR) ONLY. Engine rebuilding will be at cost to the competitor and meet the maximum horse power window set by TA2 NZ Racing. The faulty/worn engine will be sent for repair and a report will be given to the owner on the failure of that engine. If economical, it will be repaired, dyno checked and Category sealed. If uneconomical to repair, a new engine will be ordered to replace TA2 NZ/PBR stock. The failed engine will be returned to the owner in as is condition. The replacement engine will remain the property of TA2 NZ until all costs are paid in full.

- (v) Any engine found to have missing or broken Category seals will be deemed illegal until the Category seal is replaced at the discretion of the Series scrutineer.
- (w) These engine Technical Regulations are in place to protect the integrity and cost effectiveness of the TA2 Muscle Car Series. Any breach of the engine regulations will result in a penalty. If you are unsure of a modification or wish to make a repair that requires the removal of an engine Category seal, check with TA2 NZ Racing technical representative before attempting repair. No repairs outside of TA2 NZ/PBR will be allowed.

6.0 Driveline

6.1 Transmission (Only TA2 NZ Category sealed transmissions are eligible)

TA2 NZ/ AUSTRALIA Spec G-Force Transmission G-101a is to be used. Ratio as follows:

Gear	Ratio
1 st	1.93:1
2 nd	1.45:1
3 rd	1.17:1
4 th	1.00:1

- (a) The Shifter must remain as supplied. The HT4000 shift lever can be changed to suit the driver's preference.
- (b) The shift must remain H in pattern and mechanical to be operated by linkages and gear shifting only via positive means from the driver's seat.
- (c) Transmissions must always retain an operational reverse gear.
- (d) Transmission repairs can be performed by a suitability qualified person but must be checked and Category sealed by the TA2 NZ Racing Series Scrutineer. Remanufactured transmissions are available via TA2 NZ.
- (e) Transmission must remain mounted to the engine by the 0TA2 NZ Controlled Part bell housing.
- (f) A TA2 NZ Controlled Part Transmission pump and cooler is permitted. Part no. TIL40-524.
- (g) A complete kit including mounting brackets, hoses, fittings, pump, and cooler is available via TA2 NZ. Part no. TA2-0031.

6.2 Clutch and Bell Housing

- (a) The TA2 NZ Controlled Part clutch and pressure plate are a single plate design of the same size as the original (290mm).
- (b) Clutch operation is to be via a TA2 NZ Controlled Part internal slave cylinder.
- (c) A TA2 NZ Controlled Part clutch master cylinder is to remain as standard.
- (d) Flywheel/clutch assembly is a TA2 NZ Controlled part.

6.3 Driveshaft

- (a) The TA2 NZ Controlled Part Driveshaft must remain one piece and of same dimensions of the factory fitted drive shaft. Part no.244000.

- (b) Yokes are unregulated.
- (c) Universal joints are unregulated but must be a four-roller conventional commercially available type joint.

6.4 Differential

- (a) The TA2 NZ Controlled Part Axles must remain unmodified. No machining or drilling permitted.
- (b) Diff spec ratio is 4.11:1. Any secondary gear set ratio is allowed.
- (c) No camber or toe adjustable hubs are permitted.
- (d) No method of adjusting rear wheel camber permitted.
- (e) Maximum of 3mm of camber +/- vertical.
- (f) Maximum of 3mm of toe +/- horizontal.

7.0 Brakes

- (a) The brake package fitted to the TA2 car is a TA2 NZ Controlled Part and must remain the same specifications, supplied as standard, with the allowance of the option of Wilwood master cylinder's.

Part no. WW260-10280 1-1/8 bore

Part no. WW260-10278 7/8 bore

Part no. WW260-10279 1" bore

The application of cylinder sizes is at the discretion of the individual.

- (b) Howe pro brake pedal option is permitted (1.6-1.7 ratio). Part no.52696.
- (c) Brake duct box openings are to remain as standard and in factory positions, as detailed in **Appendix 2 & 2A** and as measured below in (d) and (e).
- (d) Mustang/Camaro 255mm +/- 5mm wide 120mm +/- 5mm high.
- (e) Dodge 210mm +/- 5mm wide 120 +/- 5mm high and 255mm diagonally from bottom to top corners.
- (f) Relocation of duct grill mesh from front of box to middle of box is permitted however, the mesh must be maintained.
- (g) Brake duct box upgrade for Dodge bodied cars are permissible. Part no.TA2-0034.
- (h) Front rotors are a TA2 NZ Controlled Part Wilwood brand.
- (i) Rear rotors are a TA2 NZ Controlled Part Wilwood brand.
- (j) Only TA2 NZ Controlled Part Wilwood calipers can be used.
- (k) Front Caliper part no. WW120-13948N Right, part no. WW120-13949N Left (GN6).
- (l) Rear Caliper part no. WW120-13263N (Superlite 4).
- (m) No Caliper spacers permitted.
- (n) Only TA2 NZ Controlled Part Circo pads are permitted for qualifying and racing.

- (o) No cutting or modifying of brake pads allowed.
- (p) The TA2 NZ Controlled Part Master cylinder must remain unmodified. Refer to Article 7 (a).
- (q) The TA2 NZ Controlled Part Brake bias adjuster must remain in original location. Part no. 52620.
- (r) Brake line material and size is unregulated.
- (s) All four-wheel brakes must always be operational.
- (t) No bracing or modification of caliper mounts, front, or rear.
- (u) Brake bias gauges are unregulated.
- (v) Removal/ fitting of controlled part no. brake fans are permitted.
- (w) Upgraded front rotor cooling hose is permitted however, must be TA2 spec kit - part no. TA2-0032 4" cooling hose upgrade.

8.0 Suspension and Steering

8.1. Suspension: Front

- (a) No modification that changes the geometry or action of any suspension component or a modification that changes the arc, STI, KPI, or motion ratio is permitted. Suspension geometry may only be adjusted within the limits of standard spec supplied equipment of the TA2 NZ/PBR Spec TA2 car.
- (b) Upper Control arms must remain unmodified and are a TA2 NZ Controlled Part including ball joints and pins.
- (c) Upright (stub axle) must remain unmodified and are a TA2 NZ Controlled Part including spindle slug.
- (d) Lower control arms must remain unmodified and are a TA2 NZ Controlled Part including ball joints and pins.
- (e) Castor Bar (Radius Rod) must remain unmodified.
- (f) All chassis mounts must fit within the original measurements (3mm tolerance).
- (g) Any Howe spec shims are permissible on the top arm to facilitate desired wheel alignment specifications however, the factory length bolt of 2 ½" must be retained.
- (h) Shock absorbers are to be the TA2 NZ Controlled Part Penske 7500 Series single adjustable only.
- (i) NO Re-valving of the shock absorber is permitted. No additional external method of adjusting bump or rebound characteristics will be permitted and no other modifications allowed. No external nitrogen canisters are permitted. There is an allowance for coil over adjusting sleeve (Silicone hose that fits over the coil over body threaded section and secured via hose clamp to prevent adjuster from rotating). The sole purpose of this is to reduce the damage to the coil over body threaded section from adjuster ring locking screw.
- (j) All shocks must remain Category sealed as tested/logged and dynoed by TA2 NZ.
- (k) Control valving is compulsory.
- (l) Bump stops and extension limiters are not permitted.

- (m) Front ride height measurement reference location (refer to **Appendix 7**) is to be no less than 65mm at the completion of any qualifying and or racing sessions with no less than 20 psi of tyre pressure at the measured corner and at a minimum race weight including the Driver of no less than 1250kg.
- (n) The TA2 NZ Controlled Part Coil spring must remain in original location and must be of Hypercoil brand only, purchased via TA2 NZ.
- (o) Coil spring range: Front 350-750lb, Rear 200-500lb.
- (p) One spring plus one helper spring per wheel. The helper spring is optional. Helper or tender springs are permitted, providing they remain fully bound (compressed) when weight of vehicle at normal ride height is applied.
- (q) Heim Joints are unregulated.
- (r) Springs are a controlled part supplied by TA2 NZ and must be within 10% of rating shown.
- (s) Only the TA2 NZ Controlled Part Howe branded TA2 NZ/PBR spec Upper and Lower Ball Joints are permitted. The front sway bar must always remain connected as delivered by the factory and in all conditions. Only the TA2 NZ Controlled Part factory marked and supplied 250 & 170 front sway bars are to be used without any modifications to any surface of the sway bar.

8.2. Suspension: Rear

- (a) No modification to the differential mounts location or chassis to differential mounts location is permitted. Any modification to the position of these mounts, pick up points, or mounting holes in these mounts, will result in a penalty.
- (b) Differential housing must be as standard in the caliper location and suspension locations are to remain in as standard positions.
- (c) All differential mounting points must match CAD drawings available from TA2 NZ Racing Management upon request or as detailed in **Appendix 1** of these Regulations.
- (d) Upper and lower trailing arms are a TA2 NZ Controlled Part.
- (e) Panhard bar or watts linkage are a TA2 NZ Controlled Part.
- (f) Pinion angle is unregulated.
- (g) No remote adjusters for sway bars, pan-hard bars, watts linkage or rear end top link are permissible.
- (h) Shock absorbers are to be the TA2 NZ Controlled Part Penske 7500 Series single adjustable only.
- (i) NO REVALVING IS PERMITTED. No additional external method of adjusting bump or rebound characteristics will be permitted and no other modifications allowed. No external nitrogen canisters are permitted. There is an allowance for coil over adjusting sleeves (Silicone hose that fits over the coil over body threaded section and secured via hose clamp to prevent adjuster from rotating). The sole purpose of this is to reduce the damage to the coil over body threaded section from adjuster ring locking screw.
- (j) All shocks must remain Category sealed as tested/logged and dynode by TA2 NZ.
- (k) Bump stops and extension limiters are not permitted.
- (l) One spring plus one helper spring per wheel. Helper or tender springs are permitted, providing they remain fully bound (compressed) when weight of car at normal ride height is applied.

- (m) Rear ride height measurement reference location (refer to Appendix 8) is to be no less than 65mm at the completion of any qualifying and or racing sessions with no less than 20 psi of tyre pressure at the measured corner and at a competition race weight of no less than 1250kg.
- (n) It is permissible to disconnect or remove the rear sway bar.
- (o) If the rear sway bar is to be used it must be the TA2 NZ Controlled Part sway bar from the factory including mounting hardware and cannot be modified in any-way.
- (p) Heating and bending of the standard sway bar is not permitted.
- (q) The bottom hole in the 3rd link front chassis plate is a global addition to the late model (metallic grey) chassis and is not permitted to be used. Only the top and 2nd holes are permitted to be used for suspension set up. See Image on **Appendix 6**.

8.3. Steering

- (a) The TA2 NZ Controlled Part Woodward 18.25" rack only. No Modifications are allowed. Torsion Bar changes are permitted.
- (b) Steering column may be adjusted, lengthened, or shortened to suit driver preference. No modifications are permissible. There is ample adjustment to cater for multiple driving positions.
- (c) Side steering rods are a TA2 NZ Controlled Part . No welding or joining. Must be of aluminium construction and be original fitment.
- (d) Power steering lines and pump outlet fittings may be changed.
- (e) Power steering pump must remain belt driven from the front of the engine crankshaft.
- (f) No modification to the steering geometry is permitted. Any modified steering geometry will result in a penalty.

9.0 Electrical and Data

9.1. Electrical

- (a) Battery must be a dry cell race type 12 volt. The battery must remain in the original location within 50mm in any direction.
- (b) TA2 NZ Controlled Part Factory wiring looms only. TA2 NZ Controlled Part MoTeC loom only permitted with no alterations allowed.
- (c) Switch gear is free but ignition "On/Off" and "Start" button must be clearly marked.
- (d) Gauges or electronic dash MoTeC C125/C127 is permitted for GEN 6 Cars. Logging is only allowed through MoTeC and factory ECU RPM output only. A track timer is permitted with no additional inputs via analogue or CAN are permitted.
- (e) Transmission temperature input can be substituted with TPS reference. TA2 spec interface loom is required.
- (f) Strictly no changes to the TA2 NZ Controlled Part wiring or ECU permitted.
- (g) An alternator upgrade is permissible. Part no. TA2-0020.

- (h) The master switch, located to the left-hand side of the steering wheel, must be fitted, and operate as specified by the Series Scrutineer. This master switch location must be clearly marked by a symbol, showing a red spark in a white edged blue triangle of minimum edge length 150mm, which is fitted forward on the driver door.

9.2. Data Collection

Data Collection is allowed through Motec dash, Motec Camera and V.Box Camera only through the standard channels, no additional CAN or analogue inputs into the dash are permitted.

10.0 Wheels and Tyres

10.1. Wheels

- (a) TA2 NZ Controlled Part 15" x 10" Bassett Steel wheels only. Part no. B50L55.
- (b) No wheel spacers or alterations to offset permissible.
- (c) Wheels maybe coated, painted, or chromed.
- (d) Wheels must be in good condition.
- (e) All wheel weights must be covered with race tape.
- (f) Steel wheel nuts must be used.

10.2. Tyres

- (a) The TA2 NZ Controlled Part Hoosier slicks HS3045 tyres are to be used. Available only from TA2 NZ.

Tyre	Size	Type	Compound	Wheel diameter
Dry	27.0/10.0 x 15	Bias Ply	3045	15"
Wet	27.0/10.0 x 15	Bias Ply	Wet	15"

- (b) Tyres can be lined with latex internally to aid sealing.
- (c) Hoosier wets part no. HSWET only.
- (d) No tyre grooving permitted.
- (e) The use of any device that controls, regulates, or monitors the pressure of the tyres during qualifying and or racing is not permitted.
- (f) Tyre warming devices and treatments are prohibited.
- (g) All tyres must have the Hoosier Barcode visible.
- (h) Tyre allocation will be advised in the Sporting Regulations.

11.0 Safety

- (a) All TA2 cars must be made available for Audit Safety Scrutineering when requested by the Series Scrutineer.
- (b) It is the DRIVERS responsibility to keep informed of any current regulations, or changes to those regulations, for the drivers own safety apparel.

- (c) TA2 NZ will, when possible, inform all Team owners and drivers of any updates or changes to the Technical Regulations.
- (d) All drivers' restraints (safety harness) must meet or exceed FIA 8853/98.
- (e) Six-point harnesses are a minimum requirement.
- (f) Safety harness must be mounted using the correct and approved mounting hardware and be within the manufacturer's guidelines.
- (g) The TA2 NZ Controlled Part Racetech seat must be fitted. Seat must have current SFI or FIA markings as required by MotorSport NZ.
- (h) Window nets must be fitted to the driver's window opening and restrained for all on track activities.
- (i) The window net must stop the driver's arms and/or hands from being able to protrude from the body work of the TA2 car in the event of an accident.
- (j) Window net release must work faultlessly when scrutineered and its operation must be clearly visible.
- (k) Window nets must carry the current SFI or FIA markings.
- (l) Window nets over five years of age will not be approved, regardless of their condition.
- (m) The ON board Firebombs/extinguishers that are supplied with the TA2 NZ Cars are mandatory and must be clearly marked.
- (n) Each extinguisher fitted must remain compliant with the relevant extinguisher system standard (i.e., SFI-17.1 On Board Fire Suppression Systems) including any necessary service requirements.
- (o) Read the *TA2 Owner's Manual* so you know exactly how this system works. Annual testing and tagging are mandatory and is the sole responsibility of the TA2 car owner/team.

All safety equipment must be kept in excellent condition and fitted to meet or exceed the manufacturer's requirements The Series scrutineer will have final say on any safety item issues.

12.0 Bolts and Fasteners

- (a) All major component bolts must be 'GRADE 5' or 'GRADE 8' High tensile or equivalent. No "torque to yield" bolts permissible. NO TITANIUM.
- (b) Any bolt that could influence steering or braking must not be modified in anyway. Any damaged or bent bolts or nuts must be replaced. No lightening allowed of any of these fasteners.
- (c) Pop Rivets, where used, may be replaced with another fastening means. Rivets may be coloured.
- (d) Dzuz fasteners may be replaced or up graded.
- (e) No quick release fasteners to be used on driver's protection firewalls, front, sides, or back.
- (f) All seat belt and seat fasteners to be of the highest quality.
- (g) Race tape or similar may be used in the case of on track damage but the prolonged use of race tape is discouraged.

13.0 Identification and Markings

- (a) Race numbers will be assigned, teams may request a certain race number, every effort will be made to allow the usage of that number.
 - i. Race numbers must be displayed clearly on both sides of the TA2 Race car. Number minimum height 150mm.
 - ii. Race numbers must also be displayed in yellow (min 100mm high) on the R/H top corner of the windscreen. Note: Allow room for sponsors windscreen banner (approx. 180 mm).
- (b) Branding or decals that make the TA2 car appear as a certain model of its shape (i.e. Mustang “Supersnake”) is permissible and encouraged.

14.0 Performance Upgrades or Rule Updates

TA2 Racing NZ recognizes the need for a process that allows the class to constantly move forward. Sometimes in that process, a performance or component upgrade may be sought. This upgrade might be due to a component being no longer available, a change in safety regulations, or maybe a weakness in the design that has been uncovered and replacement or strengthened part is mandated. TA2 Racing NZ will liaise with the Howe Racing Factory before any changes are implemented.

TA2 NZ Controlled Parts Option/Upgrade Components

The options listed below are what has become available to update older models to current specification builds and improvements that have been necessary to maintain reliability and cost effectiveness to the category.

PART NO.	DESCRIPTION	AVAILABILITY
244000-CHRO	Driveshaft w/Upgraded chrome moly slip yoke	Std fitment NZ
32680	Howe shifter boot	STD fitment
30799DET1	Watts Link chassis plate (Allows lower bar angle)	STD fitment on 2019+ models
52696	Howe Pro Brake pedal	Purchase option
524358	Remote clutch reservoir conversion	STD fitment on 2020+ models
52350	Improved gas pedal	STD fitment from mid 2019 models
52359	TA2 pedal stop throttle	As above
524373	Aluminium master cylinder cap (Replaces plastic cap)	Purchase option
B96100 & B96101	Steel perforated rock guards (Replaces plastic)	STD fitment 2020+ models
GF2314 1-2/3-4	Shift lever (slows shift down limits jamming)	Purchase option
MOTEC LOGING	Computer Programming	STD NZ
MOTEC TPS	TPS Extension Kit	Purchase option
MOTEC 18037	C127 Race Display Screen 7”	Purchase option
TA2-0009	Brake pressure gauge kit (Brake bias display)	STD NZ
TA2-0020	Alternator 110-amp upgrade (Replaces Power master)	STD fitment on 2019 + models
TA2-0023	Heavy duty clutch kit	STD fitment on 2020 + models
TA2-0026	Mid gearbox skid plate	Purchase option
TA2-0031	Transmission cooler pump kit	Purchase option

TA2-0033	4" Brake cooling duct kit	STD fitment on 2019+ models
TA2-0033-C	Grill inserts for upper nose - Camaro (Additional grill opening for cooling)	Purchase option
TA2-0033-M	Grill inserts for upper nose - Mustang (Additional grill opening for cooling)	Purchase option
TA2-0033	Grill opening for Dodge	Purchase option
TA2-0043	Fire system kit (Replaces 2 bottle system)	Updated when bottles are out of service date
TA2-0046	Holley valve cover option (Red, Black or Orange)	Purchase option
TA2-0047	Engine oil cooler with 9" skew blade fan	Purchase option
TA2-0049	Pinion bearing spacer	STD fitment on 2019+ models
TA2-0072 (Holley)	Engine valve cover breather kit	Purchase option
TA2-0072(STD)	Engine valve cover breather kit	Purchase option
TA2-0076	Fiberglass Airbox	Purchase option
TG2403	Detroit locker	(Mandated component 2020+) STD fitment on 2020+ models
XARO15631	Fuel sample valve (Mandated component 2019+)	STD Fitment on 2019+ models
WW260-10278	Wilwood Master Cylinder (Front)	STD fitment on 2022+ models
WW260-10279	Wilwood Master Cylinder (Rear)	STD fitment on 2022+ models

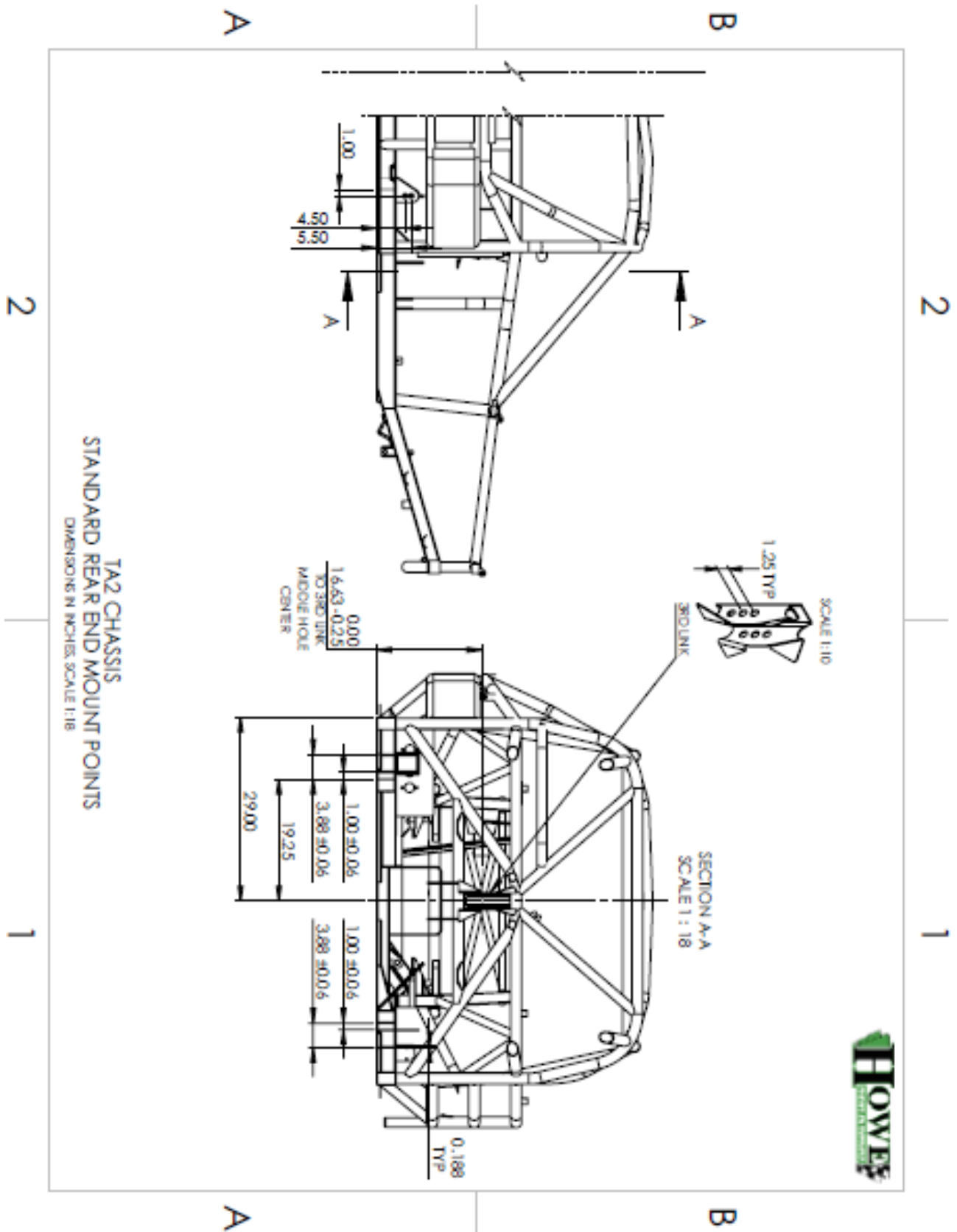

APPENDIX 2: Dodge Challenger Brake Duct Measurements.

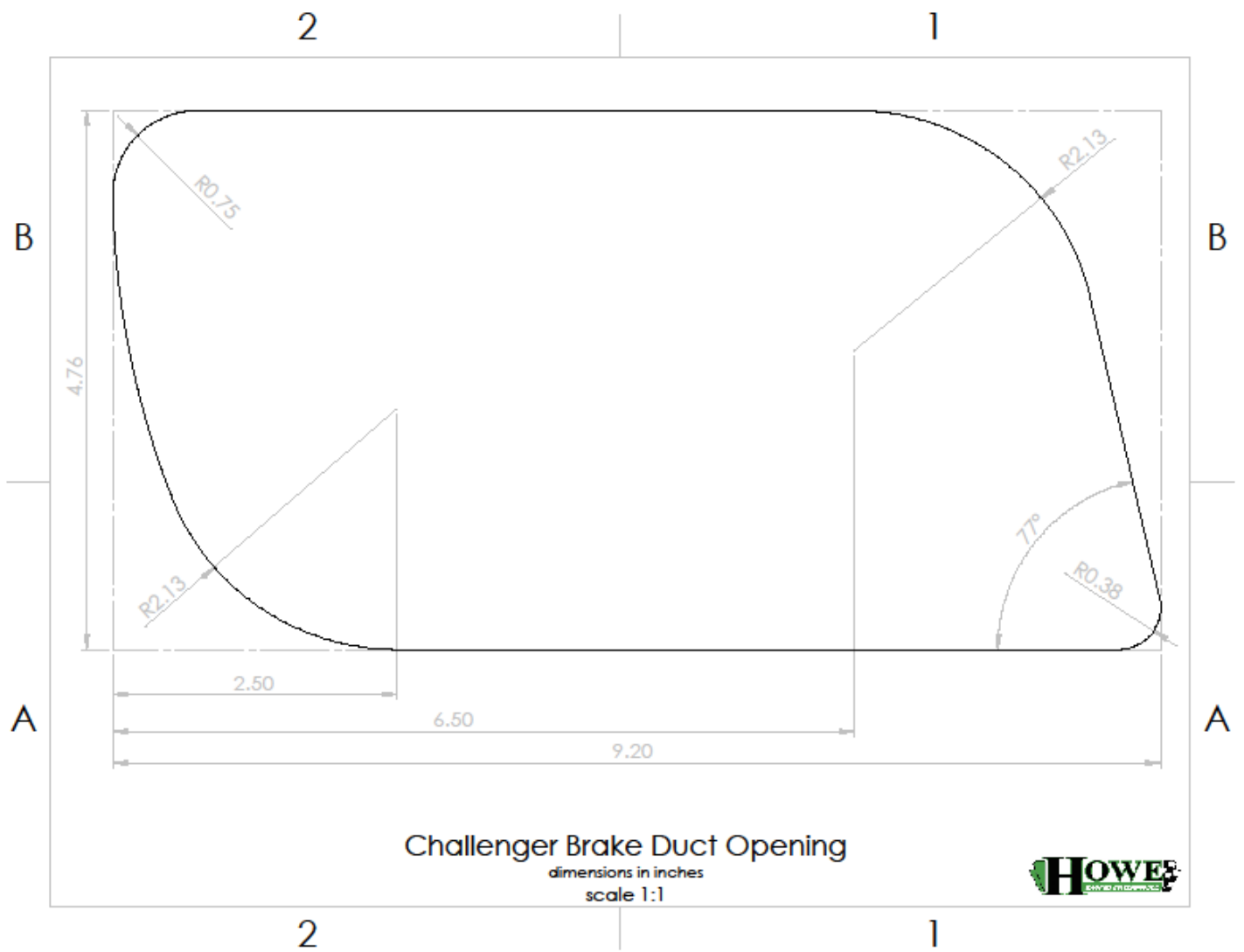

APPENDIX 2A: Chev Camaro and Ford Mustang Brake Duct Openings.

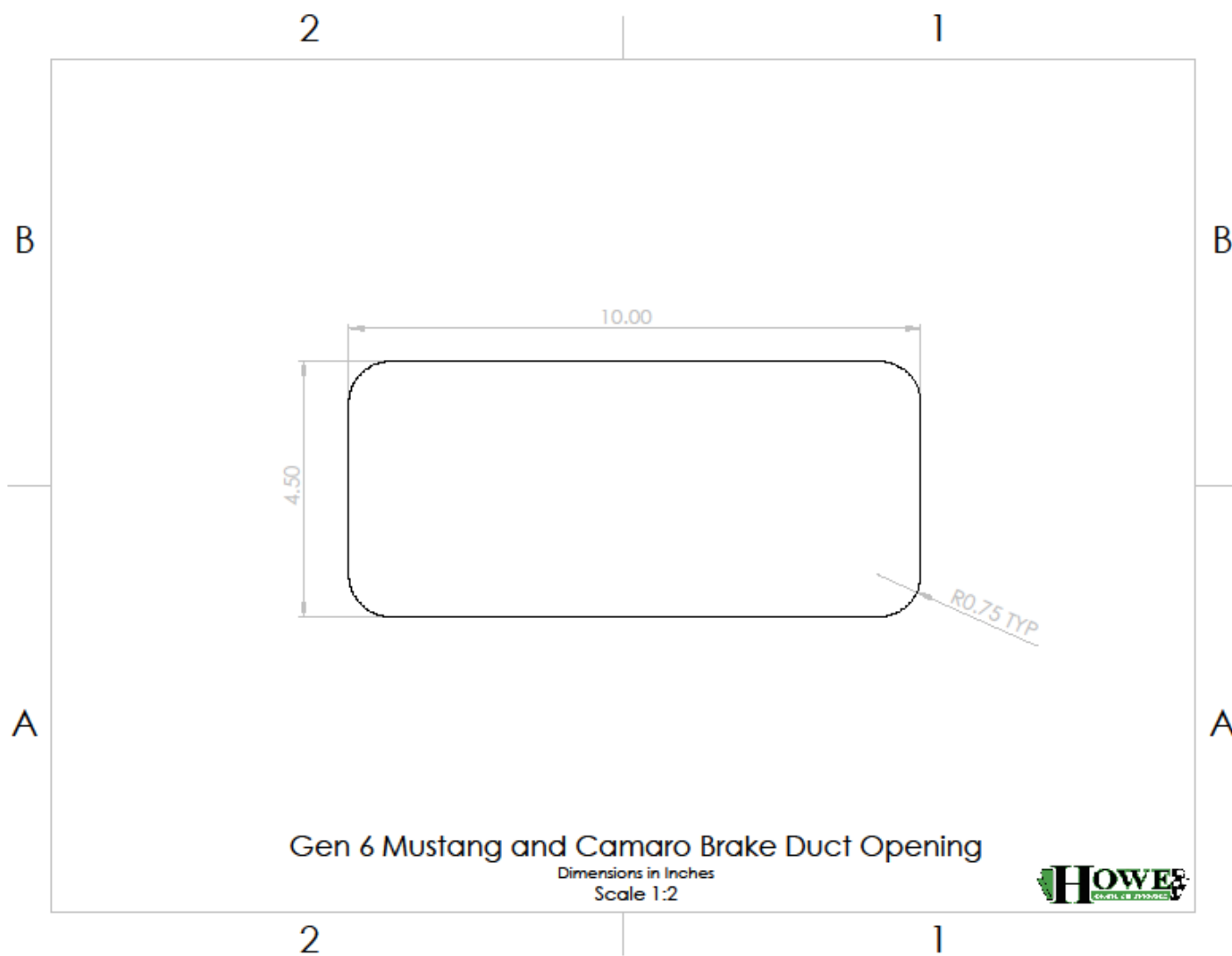

APPENDIX 3: Camaro/Mustang Splitter.

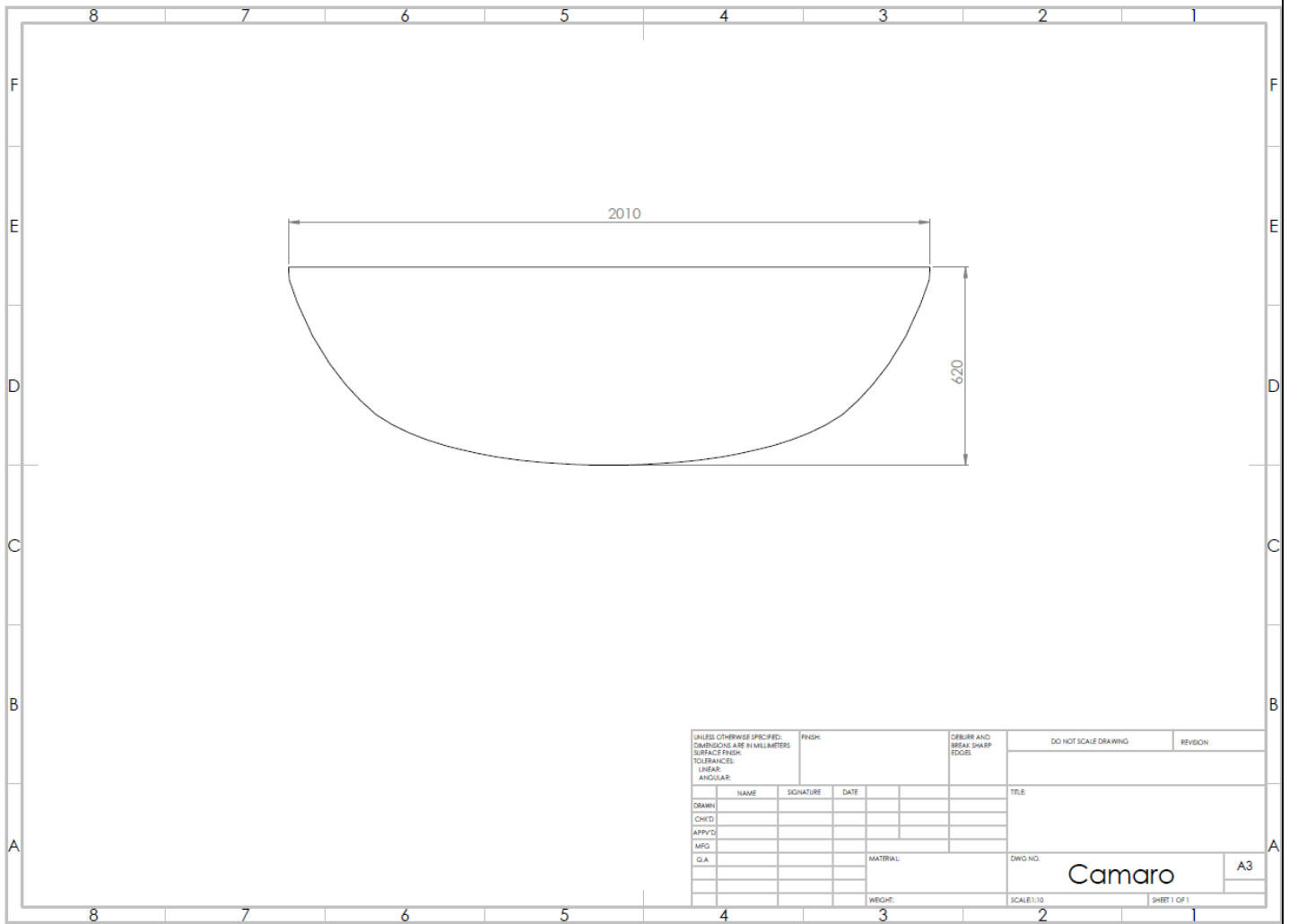

APPENDIX 4: Dodge Splitter.

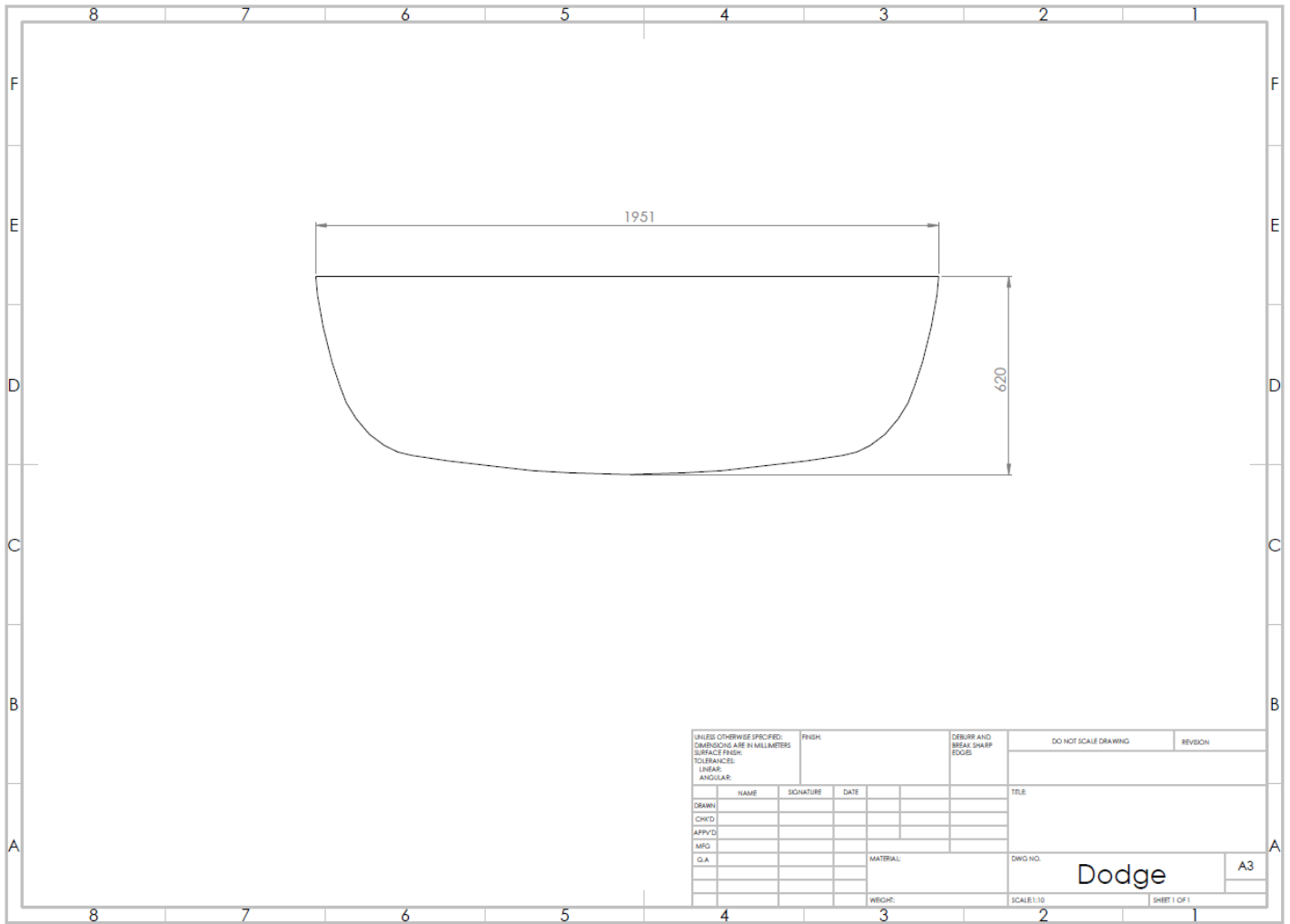

APPENDIX 5: Fuel Checking Valve.

A fuel sample point must be installed in the same location as indicated in pictures below.
Remove existing transducer install valve point and reinstall transducer into side port of sample valve.

Part #XARO15631 is the mandated valve that must be used.
Valves will be available from the parts trailer at all events.

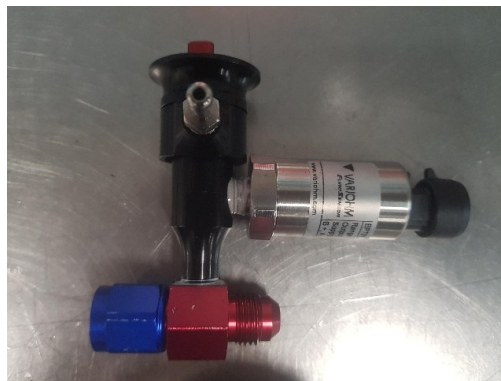
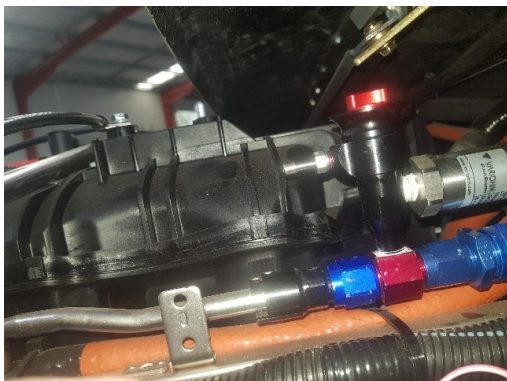

APPENDIX 6: 3rd Link Chassis Mount. The bottom hole is not to be used.



APPENDIX 7: Front location where ride height is measured 65mm.

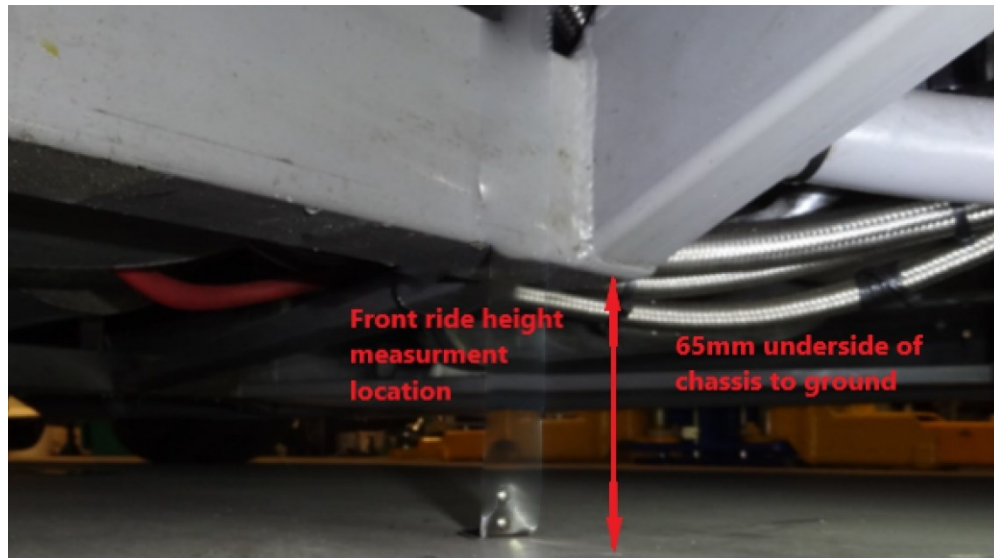

APPENDIX 8: Rear location where ride height is measured. 65mm.

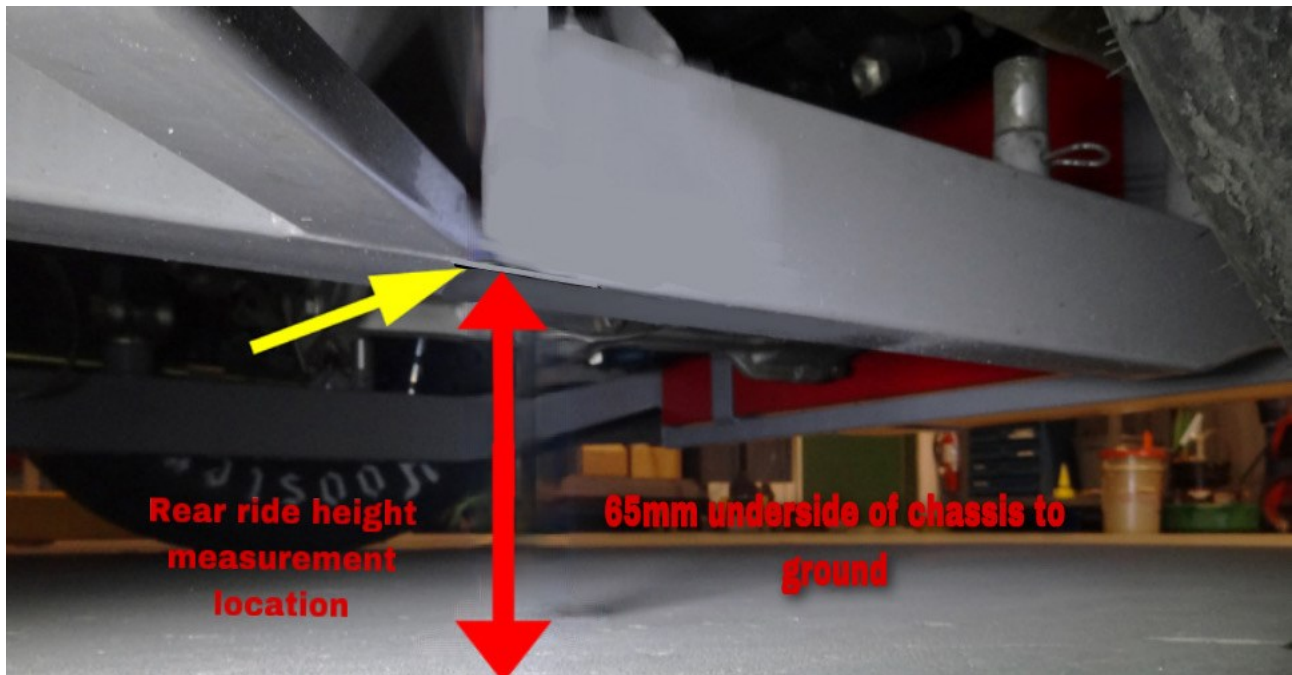

APPENDIX 9: Dodge x 2 inserts refer to picture for reference for grill opening location.

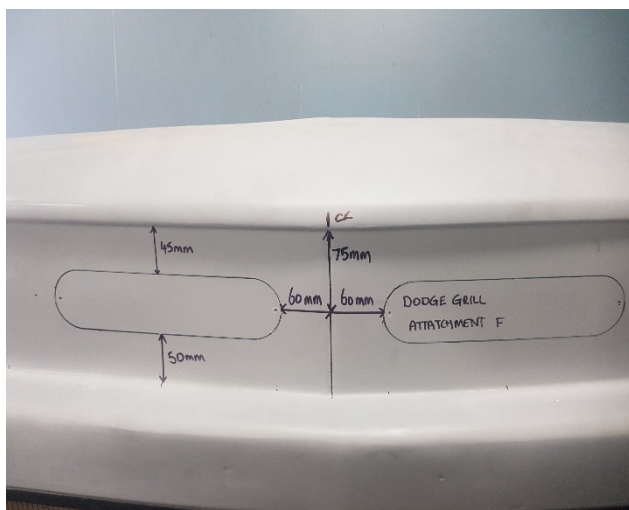
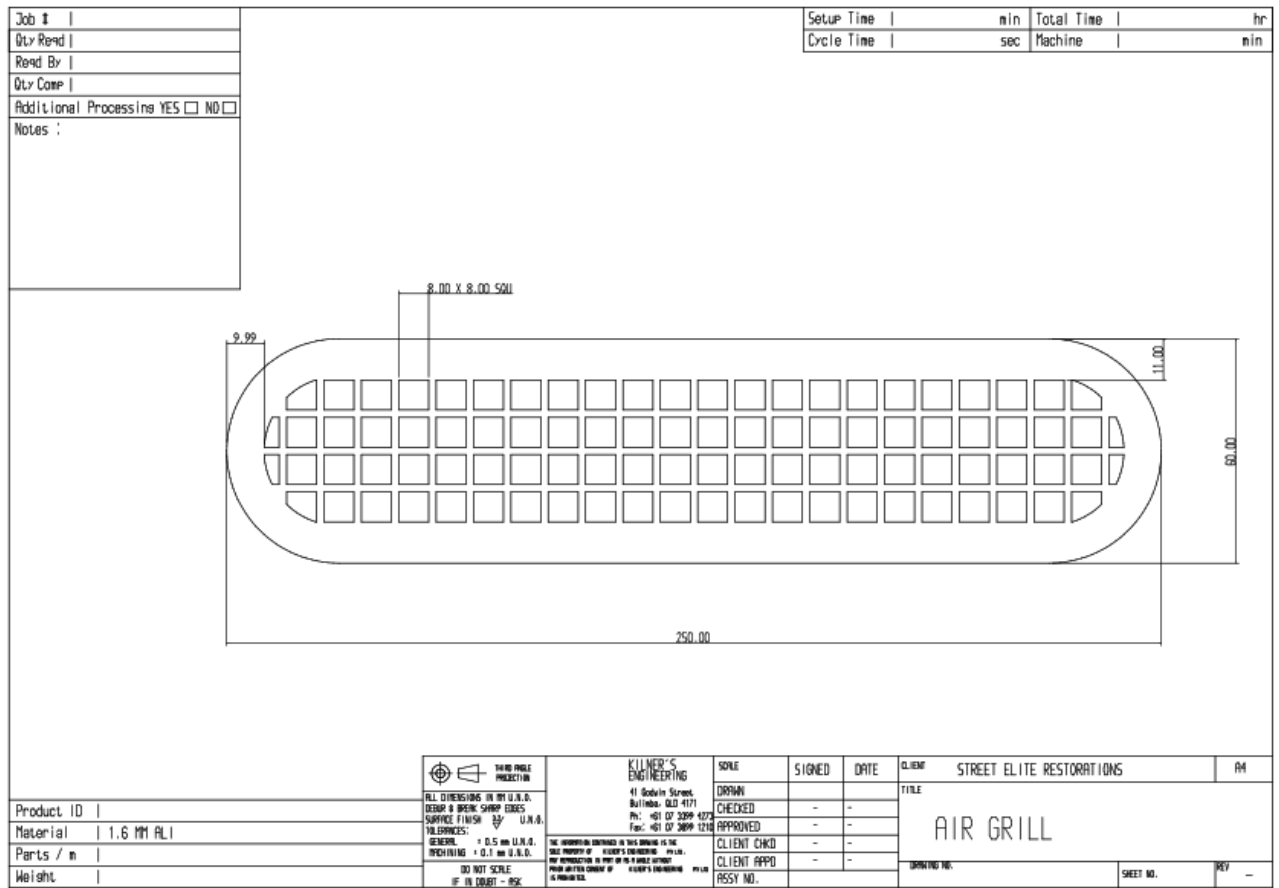

APPENDIX 10: Camaro Grill

Refer to attached picture for example of cut out it is advisable to maintain a 100mm wide bridge section in the centre of the cut out.

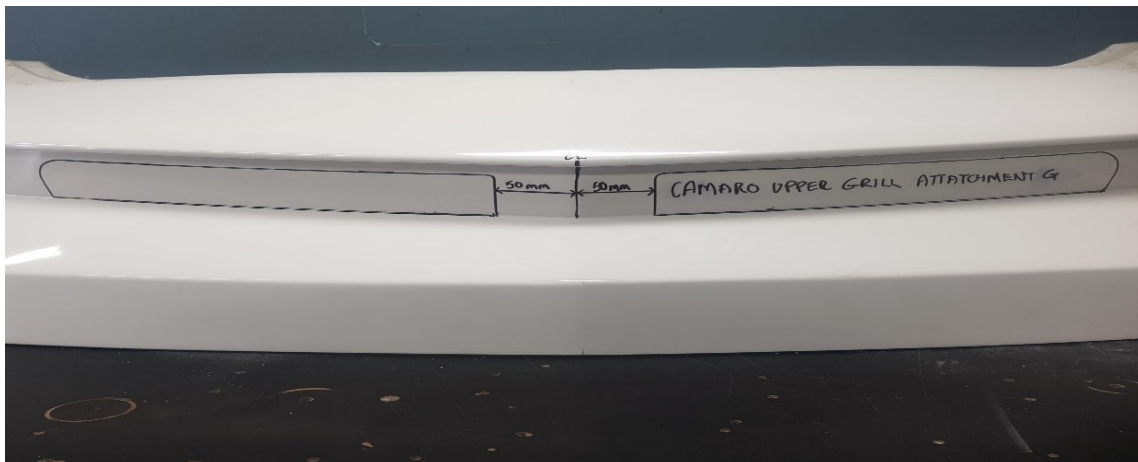
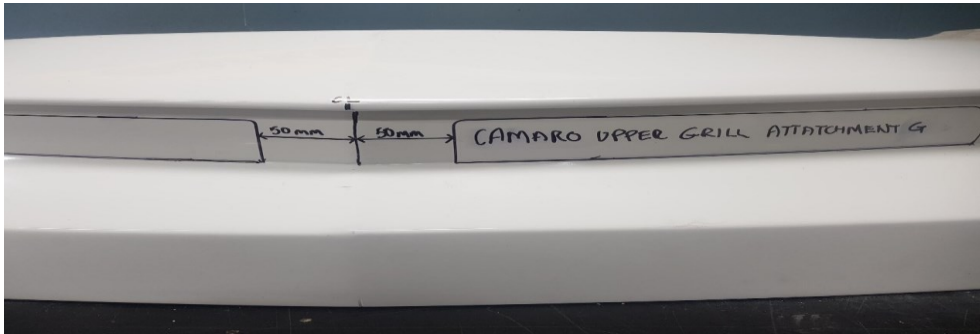
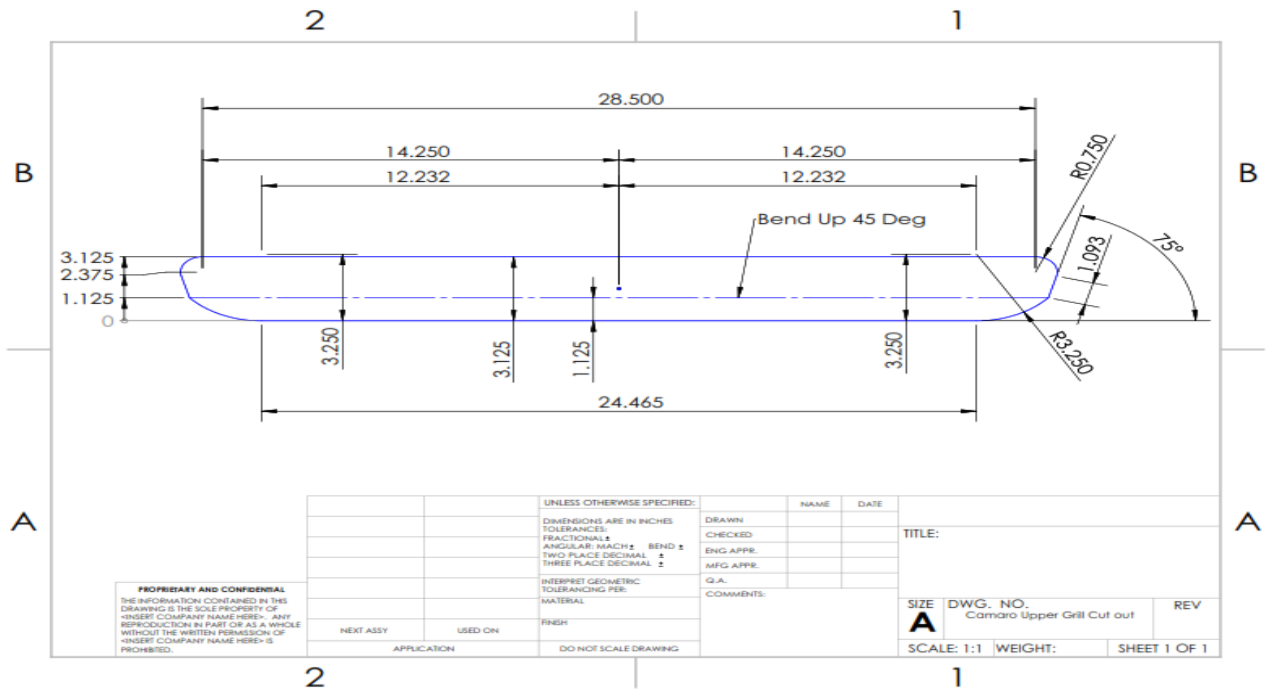

APPENDIX 11: Mustang Grill

Refer to photo for the cut-out location for the grill opening.

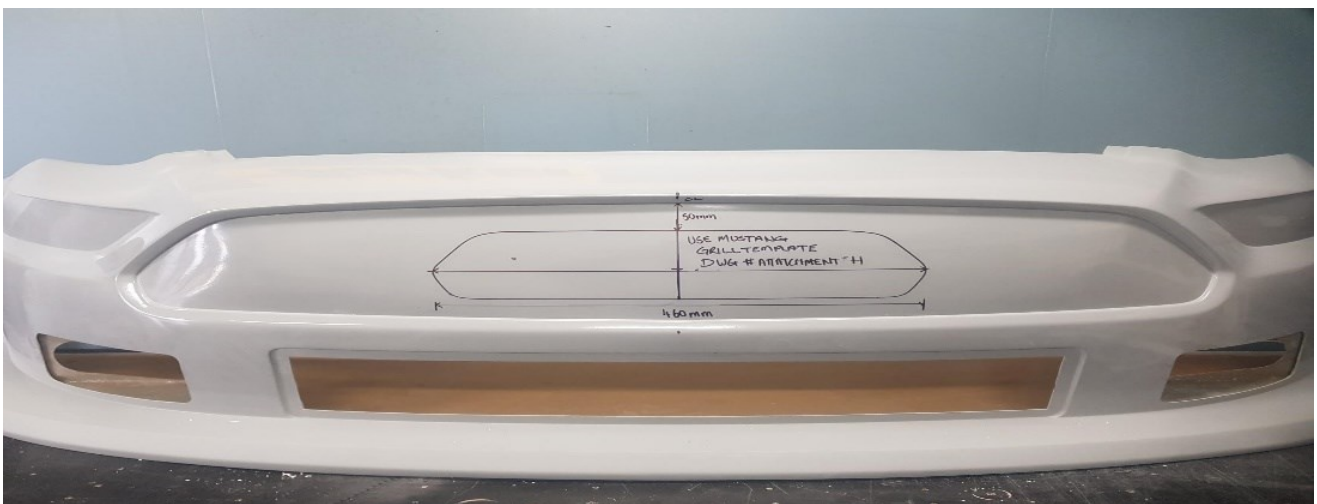
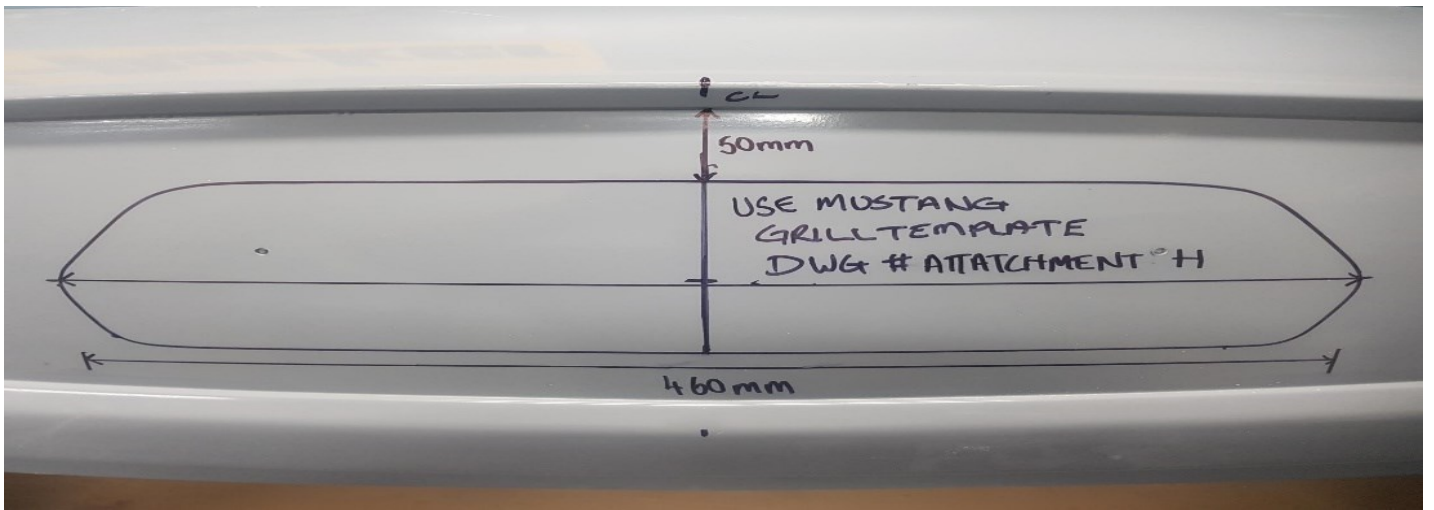
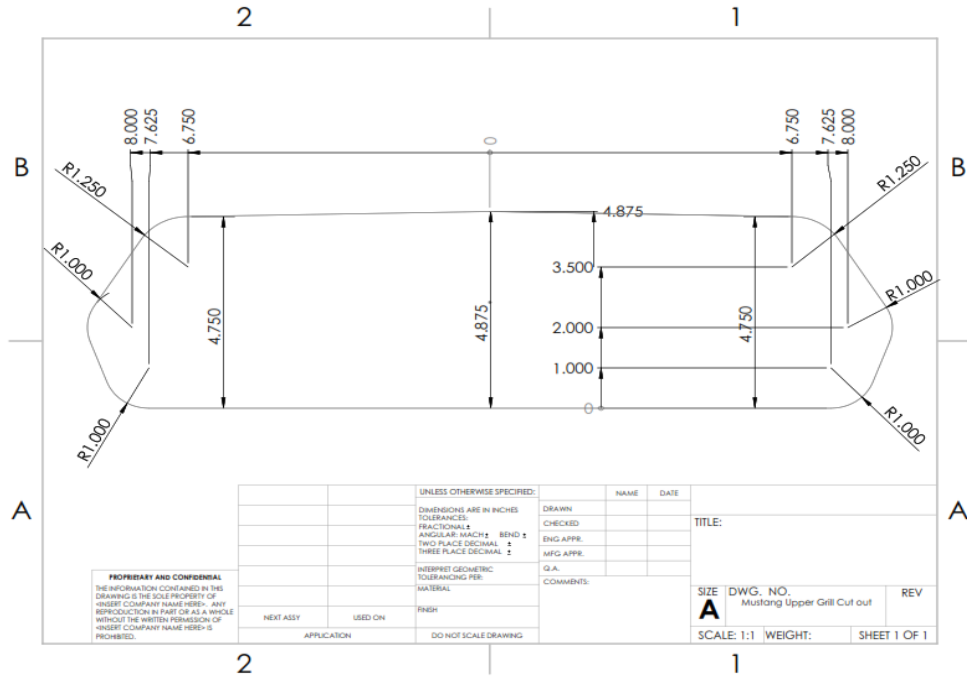

APPENDIX 12: Full wear strip attached to One-piece fibreglass nose assembly.

